



Multi-band RF combiner, diplexer, 694-803MHz/824-894MHz, double unit 4-input / 2-output, 7/16 DIN female, -155dBc, DC bypass for all ports.

General Specifications

Product Type	Multi-Band Combiner
Channel Number	2-way Diplexer
Frequency Band	694-803MHz 824-894 MHz
Input / Output	4-input and 2-output
Structure	Double Unit
Connector Interface	7/16 DIN female

Electrical Specifications

Frequency Band (MHz)	694-803	824-894
Return Loss	≤-20.8 dB	≤-20.8 dB
VSWR	≤1.20	≤1.20
Insertion Loss	≤0.5 dB	≤0.5 dB
Isolation	≥50 dB	≥50 dB
Intermodulation (3rd order)	≤-155dBc@2×43dBm	
DC Bypass	DC bypass for all ports	
Power Handling	200 watts per port	
Impedance	50 ohms	

Material Specifications

Cavity	Cavity Enclosure	Aluminum alloy
	Cavity Outer Surface Treatment	Powder coating
	Cavity Inner Surface Treatment	Cu3Ag1
	Inner Conductor	Aluminum alloy
	Inner Conductor Surface Treatment	Ag1
Connector	Outer Conductor	Brass
	Outer Conductor Surface Treatment	Tri-metal CuSnZn3
	Inner Conductor	Brass
	Inner Conductor Surface Treatment	Ag1
	Insulator	PTFE/TPX
	Gasket	Silicon rubber

Mechanical Specifications

Dimension	163×132×143 (mm, excluding connectors and brackets)
Weight	5.5 kg
Connectors Type	7/16 DIN female
Mounting	Wall and pole
Packing	1pcs in box

Environmental Specifications

Operating Temperature	-40 °C to +65 °C
Storage Temperature	-45 °C to +85 °C
Relative Humidity	5% - 95%
Application	IP67

Outline Drawing

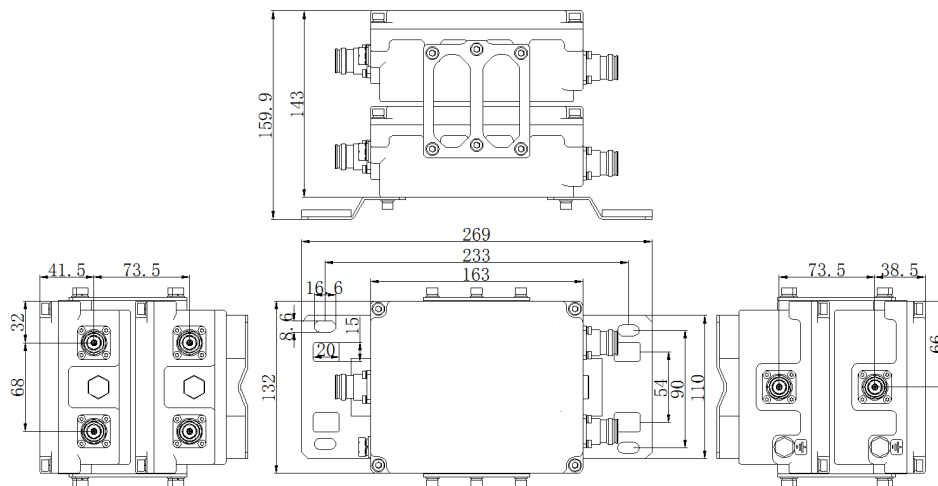

Regulatory Compliances

ISO 9001:2015	Compliant
ROHS	Compliant
China RoHS	Compliant
UK RoHS	Compliant
REACH	Compliant
EU/CE	Compliant

In the effort to improve our products, we reserve the right to make changes judged to be necessary. While the information has been carefully compiled to the best of our knowledge, nothing is intended as representation or warranty on our part and no statement herein shall be construed as recommendation to infringe existing patents. The information contained in this document is subject to change without notice.