



2-input / 1-output 3dB hybrid combiner is used for same band systems combination. This hybrid combiner covers the ultrawide frequency band of 694-4200MHz, that can be used for most of the applications in passive DAS system.

### General Specifications

Product Type	Hybrid Combiner
Frequency Band	694-4200 MHz
Input / Output	2-input / 1-output
Intermodulation (3rd order)	≤-120dBc@2×43dBm
Connector Interface	N female

### Electrical Specifications

Frequency Band	694-4200 MHz
Return Loss	≤-17.7 dB
VSWR	≤1.3
Insertion Loss	≤0.2 dB
Distribution Loss	Nominal 3 dB
Distribution Loss Ripple	±0.6 dB
Isolation	≥20 dB
Intermodulation (3rd order)	≤-120dBc@2×43dBm
Power Handling	100 watts per port
Impedance	50 ohms

### Material Specifications

Cavity	Cavity Enclosure	Aluminum alloy
	Cavity Outer Surface Treatment	Conductive oxidation / Painting
	Cavity Inner Surface Treatment	Cu3Ag1
	Inner Conductor	Aluminum alloy
Connector	Inner Conductor Surface Treatment	Ag1
	Outer Conductor	Brass
	Outer Conductor Surface Treatment	Tri-metal CuSnZn3
	Inner Conductor	Brass
	Inner Conductor Surface Treatment	Ag1
	Insulator	PTFE/TPX
	Gasket	Silicon rubber

## Mechanical Specifications

Dimension	138×47×56 mm
Weight	0.8 kg
Connectors Type	N female
Mounting	Plane
Packing	1 pcs in box

## Environmental Specifications

Operating Temperature	-40 °C to +65 °C
Storage Temperature	-45 °C to +85 °C
Relative Humidity	5% - 95%
Application	IP65

## Outline Drawing

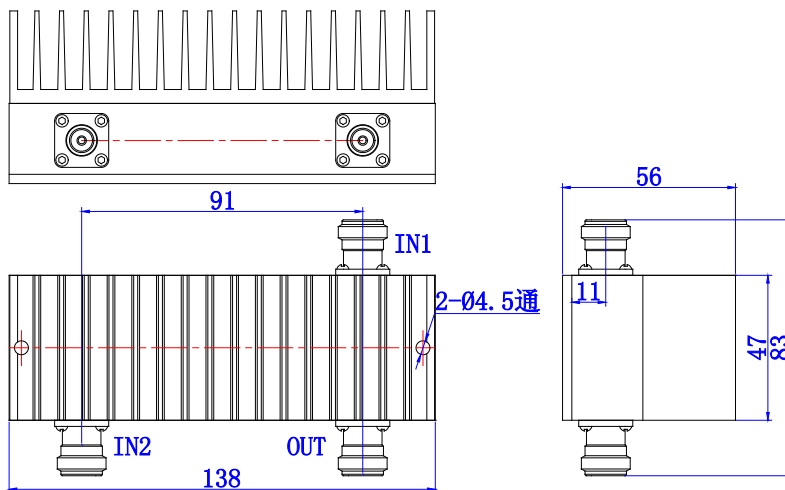

## Regulatory Compliances

ISO 9001:2015	Compliant
ROHS	Compliant
China RoHS	Compliant
UK RoHS	Compliant
REACH	Compliant
EU/CE	Compliant

In the effort to improve our products, we reserve the right to make changes judged to be necessary. While the information has been carefully compiled to the best of our knowledge, nothing is intended as representation or warranty on our part and no statement herein shall be construed as recommendation to infringe existing patents. The information contained in this document is subject to change without notice.