



The termination dummy load is designed to match the open port for RF equipment and systems. SYMAIR termination loads have compact dimensions, stable power handling and high reliability for long-term applications. With low-PIM design, the termination can avoid system interference.

General Specifications

Product Type	Low PIM RF Termination Load
Frequency Band	694-3800 MHz
Power Handling	50 Watts
Intermodulation (3rd order)	$\leq -150\text{dBc}@2\times 43\text{dBm}$
Connector Interface	4.3-10 male

Electrical Specifications

Frequency Band	694-3800 MHz
Return Loss	$\leq -19.1\text{ dB}$
VSWR	≤ 1.25
Intermodulation (3rd order)	$\leq -150\text{dBc}@2\times 43\text{dBm}$
Power Handling	50 watts
Impedance	50 ohms

Material Specifications

Cavity	Cavity Enclosure	Aluminum alloy
	Cavity Outer Surface Treatment	Conductive oxidation / Painting
	Cavity Inner Surface Treatment	Cu3Ag1
	Inner Conductor	Aluminum alloy
Connector	Inner Conductor Surface Treatment	Ag1
	Outer Conductor	Brass
	Outer Conductor Surface Treatment	Tri-metal CuSnZn3
	Inner Conductor	Brass
	Inner Conductor Surface Treatment	Ag1
	Insulator	PTFE/TPX
	Gasket	Silicon rubber

Mechanical Specifications

Dimension	156×166×60 mm
Weight	1.5 kg
Connectors Type	4.3-10 male
Mounting	Plane
Packing	1 pcs in box

Environmental Specifications

Operating Temperature	-40 °C to +65 °C
Storage Temperature	-45 °C to +85 °C
Relative Humidity	5% - 95%
Application	Indoor

Outline Drawing

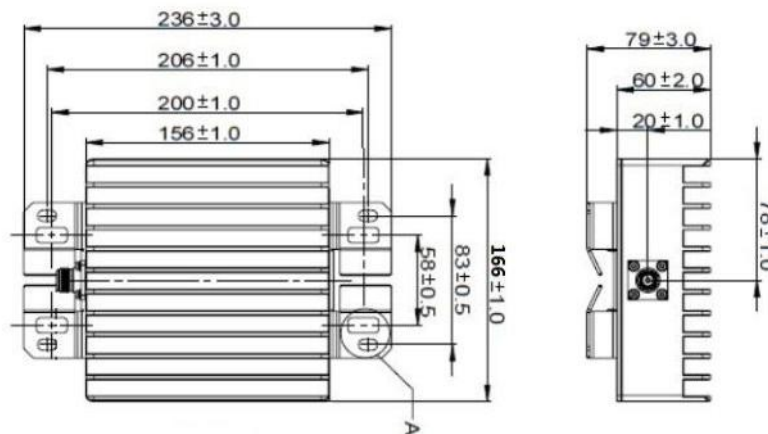

Regulatory Compliances

ISO 9001:2015	Compliant
ROHS	Compliant
China RoHS	Compliant
UK RoHS	Compliant
REACH	Compliant
EU/CE	Compliant

In the effort to improve our products, we reserve the right to make changes judged to be necessary. While the information has been carefully compiled to the best of our knowledge, nothing is intended as representation or warranty on our part and no statement herein shall be construed as recommendation to infringe existing patents. The information contained in this document is subject to change without notice.