



The attenuator is designed for RF power level adjustment. SYMAIR RF attenuators have compact dimensions, stable power handling and high reliability for long-term applications. Additionally, SYMAIR can offer low PIM models for variable PIM value requirements.

**XX refers to the optional attenuation values.*

General Specifications

Product Type	RF Attenuator
Frequency Band	DC-6000 MHz
Power Handling	10 Watts
Connector Interface	N-male to N-female

Electrical Specifications

Frequency Band	DC-6000 MHz						
Return Loss	≤-20.8 dB for DC-3000MHz ≤-19.1 dB for 3000-6000MHz						
VSWR	≤1.20 for DC-3000MHz ≤1.25 for 3000-6000MHz						
Attenuation	1-9 dB	10 dB	15 dB	20 dB	25 dB	30 dB	40 dB
Accuracy	±0.5 dB	±0.5 dB	±0.5 dB	±0.6 dB	±0.8 dB	±0.8 dB	±1.0 dB
Power Handling	10 watts						
Impedance	50 ohms						

Material Specifications

Cavity	Cavity Enclosure	Aluminum alloy
	Cavity Outer Surface Treatment	Conductive oxidation
Connector	Cavity Inner Surface Treatment	Cu3Ag1
	Inner Conductor	Aluminum alloy
	Inner Conductor Surface Treatment	Ag1
	Outer Conductor	Brass
	Outer Conductor Surface Treatment	Tri-metal CuSnZn3
	Inner Conductor	Brass
	Inner Conductor Surface Treatment	Ag1
	Insulator	PTFE/TPX
	Gasket	Silicon rubber

Mechanical Specifications

Dimension	φ35×67 mm (Excluding connectors and brackets)
Weight	150 g
Connectors Type	N male to N female
Mounting	Plane
Packing	1pcs in box

Environmental Specifications

Operating Temperature	-40 °C to +65 °C
Storage Temperature	-45 °C to +85 °C
Relative Humidity	5% - 95%
Application	Indoor

Outline Drawing

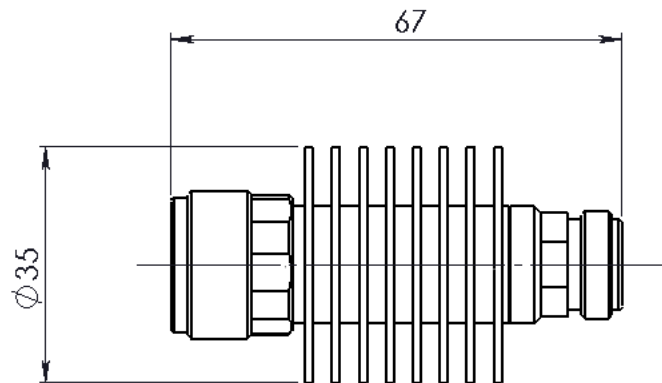

Regulatory Compliances

ISO 9001:2015	Compliant
ROHS	Compliant
China RoHS	Compliant
UK RoHS	Compliant
REACH	Compliant
EU/CE	Compliant

In the effort to improve our products, we reserve the right to make changes judged to be necessary. While the information has been carefully compiled to the best of our knowledge, but nothing is intended as representation or warranty on our part and no statement herein shall be construed as recommendation to infringe existing patents. The information contained in this document is subject to change without notice.