



The taper is widely used in the in-building DAS deployment. It has various coupling value to match system requirements. The product is designed with wide frequency band, customized connector interface, high power handling, low PIM performance and high reliability for indoor coverage applications.

*\* XX in the PN refers to the coupling values.*

## General Specifications

Product Type	RF taper
Frequency Band	694-3800 MHz
Coupling Values	5dB, 6dB, 7dB, 8dB, 10dB, 12dB, 13dB, 15dB, 20dB, 25dB, 30dB, 35dB, 40dB
Connector Interface	4.3-10 female

## Electrical Specifications

Frequency Band (MHz)	694-3800 MHz	
Insertion Loss	≤0.1dB	
VSWR	≤1.3	
Coupling Values	Coupling Attenuation	Distribution Loss
5dB	5±1.5dB	≤2.1dB
6dB	6±1.5dB	≤1.7dB
7dB	7±1.5dB	≤1.5dB
8dB	8±1.5dB	≤1.4dB
10dB	10±1.8dB	≤1.0dB
12dB	12±1.8dB	≤0.6dB
13dB	13±1.8dB	≤0.6dB
15dB	15±1.8dB	≤0.5dB
20dB	20±2.0dB	≤0.4dB
25dB	25±2.0dB	≤0.4dB
30dB	30±2.0dB	≤0.3dB
35dB	35±2.0dB	≤0.3dB
40dB	40±2.2dB	≤0.3dB
Power Handling	500W	
Intermodulation, 2×43dBm	≤-155dBc	
Impedance	50 ohms	

## Mechanical Specifications

Dimension	107x25x25 mm (Excluding connectors and brackets)
Weight	0.5 kg
Connectors Type	4.3-10 female
Mounting	Wall or rack
Packing	1pcs in box

## Environmental Specifications

Operating Temperature	-40 °C to +65 °C
Storage Temperature	-45 °C to +85 °C
Relative Humidity	5% - 95%
Application	IP65, indoor and outdoor

## Outline Drawing

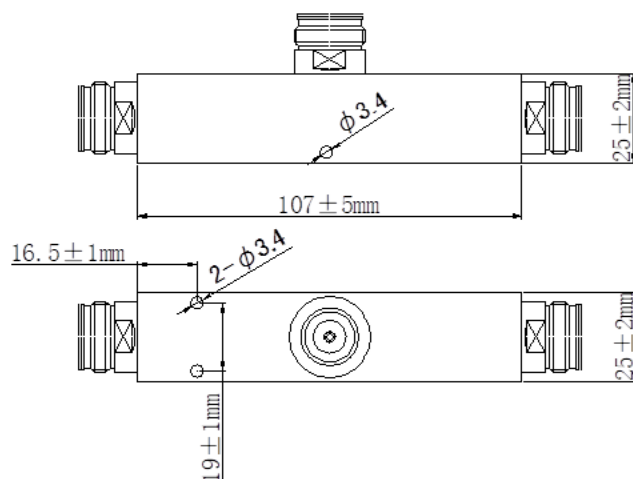

## Regulatory Compliances

ISO 9001:2015	Compliant
ROHS	Compliant
China RoHS	Compliant
UK RoHS	Compliant
REACH	Compliant
EU/CE	Compliant

In the effort to improve our products, we reserve the right to make changes judged to be necessary. While the information has been carefully compiled to the best of our knowledge, but nothing is intended as representation or warranty on our part and no statement herein shall be construed as recommendation to infringe existing patents. The information contained in this document is subject to change without notice.