



The hybrid coupler is widely used in the in-building DAS deployment to combine and mix the same-band systems. The product is designed with wide frequency band, customized connector interface, high power handling, low PIM performance and high reliability for indoor and outdoor coverage applications.

General Specifications

Product Type	RF Hybrid Coupler
Frequency Band	694-4200 MHz
Port Number	2-input / 2-output
Connector Interface	7/16 DIN female

Electrical Specifications

Frequency Band (MHz)	694-4200 MHz
Return Loss	≤ -18 dB
VSWR	≤ 1.3
Insertion Loss	≤ 0.2 dB
Distribution Loss	Nominal 3 dB
Distribution Loss Ripple	± 0.6 dB
Isolation	≥ 23 dB
Power Handling	500W
Intermodulation, 2×43dBm	≤ -155dBc
Impedance	50 ohms

Material Specifications

Cavity	Cavity Enclosure	Aluminum alloy
	Cavity Outer Surface Treatment	Black painting
	Cavity Inner Surface Treatment	Cu3Ag1
	Inner Conductor	Aluminum alloy
Connector	Inner Conductor Surface Treatment	Ag1
	Outer Conductor	Brass
	Outer Conductor Surface Treatment	Tri-metal CuSnZn3
	Inner Conductor	Brass
	Inner Conductor Surface Treatment	Ag1
	Insulator	PTFE/TPX
	Gasket	Silicon rubber

Mechanical Specifications

Dimension	147x44x36 mm (Excluding connectors and brackets)
Weight	0.9 kg
Connectors Type	7/16 DIN female
Mounting	Wall or rack
Packing	1pcs in box

Environmental Specifications

Operating Temperature	-40 °C to +65 °C
Storage Temperature	-45 °C to +85 °C
Relative Humidity	5% - 95%
Application	IP65, indoor and outdoor

Outline Drawing

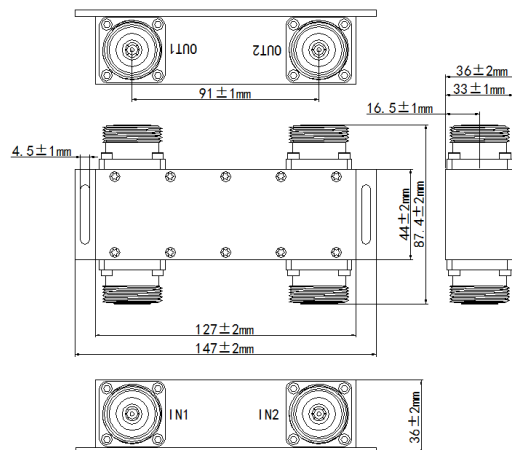

Regulatory Compliances

ISO 9001:2015	Compliant
ROHS	Compliant
China RoHS	Compliant
UK RoHS	Compliant
REACH	Compliant
EU/CE	Compliant

In the effort to improve our products, we reserve the right to make changes judged to be necessary. While the information has been carefully compiled to the best of our knowledge, but nothing is intended as representation or warranty on our part and no statement herein shall be construed as recommendation to infringe existing patents. The information contained in this document is subject to change without notice.